



INSTRUCTION MANUAL

VHF AIR BAND TRANSCEIVER

IC-A110EURO

Icom Inc.

FOREWORD

READ ALL INSTRUCTIONS carefully and completely before using the transceiver.

SAVE THIS INSTRUCTION MANUAL — This instruction manual contains important operating instructions for the IC-A110EURO.

EXPLICIT DEFINITIONS

The explicit definitions below apply to this instruction manual.

WORD	DEFINITION
⚠ WARNING	Personal injury, fire hazard or electric shock may occur.
CAUTION	Equipment damage may occur.
NOTE	If disregarded, inconvenience only. No risk of personal injury, fire or electric shock.

Icom, Icom Inc. and  are registered trademarks of Icom Incorporated (Japan) in the United States, the United Kingdom, Germany, France, Spain, Russia and/or other countries.

CAUTIONS

⚠ WARNING! NEVER operate the transceiver with a headset or other audio accessories at high volume levels. Hearing experts advise against continuous high volume operation. If you experience a ringing in your ears, reduce the volume level or discontinue use.

NEVER connect the transceiver to an AC outlet or to a power source of **more than 32 V DC**. Such a connection will damage the transceiver.

NEVER connect the transceiver to a power source that is DC fused at more than 5 A. Accidental reverse connection will be protected by this fuse, higher fuse values will not give any protection against such accidents and the transceiver will be ruined.

DO NOT operate the transceiver near unshielded electrical blasting caps or in an explosive atmosphere.

DO NOT connect the transceiver to a power source using reverse polarity. This connection will not only blow fuses but also may damage the transceiver.

TABLE OF CONTENTS

FOREWORD	i
EXPLICIT DEFINITIONS	i
CAUTIONS	i
TABLE OF CONTENTS	ii
1 PANEL DESCRIPTION	1-3
■ Panel description	1-2
■ Function display	3
2 BASIC OPERATION	4-5
■ Power ON	4
■ Channel selection	4
■ Squelch function	5
■ Side tone function	5
■ LCD backlight control	5
■ Dial select function	5
3 SCAN OPERATION	6-7
■ Scan operation	6
■ On-hook scan	7
■ Dualwatch	7
4 MEMORY PROGRAMMING	8-9
■ Programming a memory channel	8
■ Memory names	9
5 OTHER FUNCTIONS	10-11
■ Initial set mode	10-11
6 CONNECTION AND INSTALLATION	12-13
■ Rear panel and connections	12
■ Mounting	13
■ Supplied accessories	13
7 CLONING	14
8 SPECIFICATIONS	15-17
9 OPC-871 HEADSET ADAPTER/OTHER OPTIONS.....	18-19
■ OPC-871 Headset adapter	18
■ Other Options	19

DO NOT place unit in a non-secure place to avoid inadvertent use by children.

DO NOT push the PTT when not actually desiring to transmit.

AVOID using or placing the transceiver in direct sunlight or in areas with temperatures below -30°C (-22°F) or above $+60^{\circ}\text{C}$ ($+140^{\circ}\text{F}$).

AVOID placing the transceiver in excessively dusty environments.

AVOID placing the transceiver against walls. This will obstruct heat dissipation.

AVOID the use of chemical agents such as benzine or alcohol when cleaning, as they damage the transceiver surfaces.

BE CAREFUL! The transceiver will become hot when operating continuously for long periods.

1

PANEL DESCRIPTION

■ Panel description

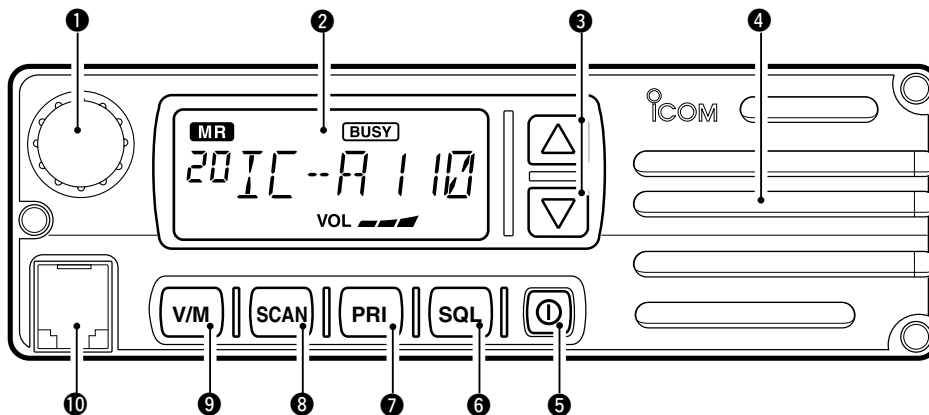

❶ TUNING [DIAL(TS)]

- ➔ Changes the operating frequency; memory channel in memory mode; set mode contents in set mode, etc.
- ➔ Push to toggle the dimmer control OFF, Low and High.
- ➔ Push and hold for 1 sec. to select the Tuning Step [TS]; 1 MHz or 10 kHz are available. (p. 5)

❷ FUNCTION DISPLAY (p. 3)

Displays the operating frequency, memory channel name, etc.

❸ VOLUME UP [▲] DOWN [▼] KEY

Adjusts the audio output level.

❹ LOUD SPEAKER

Front mounted loud speaker.

❺ POWER SWITCH [POWER]

Push and hold 500 m sec. to turn the power ON and OFF.

- ➔ The following functions are available at power ON as options:
 - Initial set mode (p. 10)
 - Cloning mode (p. 14)

6 SQL SWITCH [SQL]

- ➔ Push to turn on the squelch adjust mode. (p. 6)
- ➔ Push and hold this switch for 1 sec. to turn ON/OFF the both internal and external speaker output. (p. 4)

7 PRIORITY SWITCH [PRI]

- ➔ Push to select priority channel. (p. 11)
 - “Pr” appears on the display.

8 SCAN SWITCH [SCAN]

- ➔ Starts and stops the scan function:
 - VFO mode: VFO scan function.
 - Memory mode: Memory channel scan function. (p. 6)
- ➔ Push and hold this switch for 5 sec. to set the displayed channel as a memory lock-out channel. (p. 8)
 - “LOCK OUT” appears on the display.

9 VFO/MEMORY SWITCH [V/M]/[MW]

- ➔ Push to toggle the VFO mode or the Memory mode. (p. 4)
 - “” and memory channel number appear when memory mode is selected.
 - The transceiver has 99 memory channels.
- ➔ When VFO mode is selected;
 - Push and hold this switch for 5 sec. to program the VFO frequency to memory channel. (p. 8)
- ➔ When Memory mode is selected;
 - Push and hold this switch for 5 sec. to turn the “Memory name write mode” ON.

10 MICROPHONE CONNECTOR

Connects the supplied microphone or optional.
NEVER connect other microphones. The pin assignments may be different and the transceiver may be damaged.

MICROPHONE

The supplied microphone has a PTT switch and a cradle. The following functions are available when the microphone is taken off from the hook or put back on hook:

- ➔ Automatic scan starts when putting on hook. (p. 7)
- ➔ Automatic scan stops when taken off hook. (p. 7)

NOTE: Optional functions vary with transceiver version.

In this manual, optional functions are indicated by “OPTION” icon.

Please contact your dealer for details.

1 PANEL DESCRIPTION

■ Function display

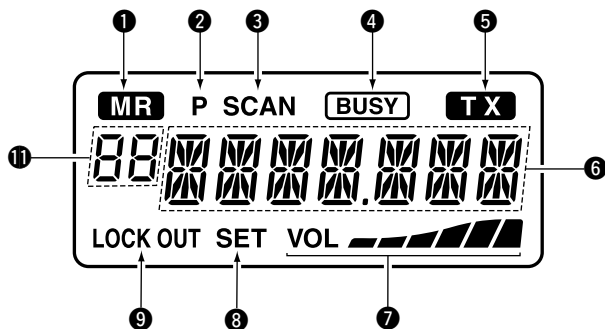

- 1 MEMORY MODE INDICATOR** (p. 5)
Appears when memory mode is selected.
- 2 DUALWATCH INDICATOR** (p. 7)
Indicates when the dualwatch function is activated.
- 3 SCAN INDICATOR** (p. 8)
Indicates when the scan function is selected.
- 4 BUSY INDICATOR** (p. 6)
“BUSY” appears when receiving a signal or when the squelch is open. (p. 6)

- 5 TX INDICATOR** (p. 5)
Appears while transmitting.

- 6 FREQUENCY DISPLAY** (p. 11)
 - ➔ Shows the operating frequency.
 - ➔ Shows the channel name when the memory name function is selected. (p. 10)

- 7 VOLUME LEVEL INDICATORS**
 - ➔ Shows the AF volume level(while receiving).

- 8 SET MODE INDICATOR**
 - ➔ Appears when the Initial set mode is selected. (p. 12)

- 10 LOCK OUT INDICATOR**
 - ➔ Appears when the channel is set as a ‘LOCK OUT’ channel. (p. 10)

- 11 MEMORY CHANNEL INDICATOR**
 - ➔ Indicates the selected memory channel number
 - ➔ ‘Pr’ appears when the priority channel is selected.

OPTION

***NOTE:** The VFO/memory switch [V/M] and the memory write switch [M/W] functions may not be available depending on version.

■ Power ON

- ① Push [POWER] to turn power ON.



- ② Operate the transceiver as indicated in the following sections.
- ③ Select the desired memory channel (or VFO frequency) with the [V/M] keys.
 - When receiving a signal, **BUSY** appears and audio is emitted from the speaker.
 - Further adjustment of audio level may be necessary at this point.
 - Push [SQL] to adjust the squelch level. (p. 6)
 - Push and hold the tuning dial for 1 sec. to select the [TS], each push increments/decrements to the frequency are either 10 kHz or 1 MHz. (p. 7)
- ④ Push and hold [PTT] to transmit, then speak into the microphone.
 - Transmit indicator **TX** lights.
- ⑤ Release [PTT] to receive.

■ Channel selection

◇ VFO/Memory selection

- ① Push [V/M] to select memory mode or VFO mode.
 - ➔ Rotate the dial to select a desired frequency/channel.
- ② During memory mode operation, push [V/M] key to transfer the memory contents to VFO.
 - Push [V/M] to select VFO mode.



NOTE: Only frequency data is transferred even if the memory channel has a memory name.

◇ External speaker output control

External speaker output can be turned OFF, if desired.

- ① Push and hold [SQL] for 1 sec.
- ② Rotate the dial to select "SP OFF".
- ③ Push [SQL] to turn to the previous mode.

NOTE: This function available both internal and external speakers.



2 BASIC OPERATION

■ Squelch function

The transceiver has a noise squelch circuit to mute undesired noise while receiving no signal.

◆ Setting the squelch level

- ① Push [SQL] to turn the level adjusting mode ON.
- ② Turn the tuning [DIAL] to select the squelch level.
 - ‘SQ 01’ is loose squelch and ‘SQ 25’ is tight squelch. (Initial level is ‘SQ 01’)
 - ‘SQ 01’ indicates that the squelch circuit is turned off.
 - “**BUSY**” appears on the display.
- ③ Push [SQL] to return to regular operation.

■ Side tone function

When using an optional headset, such as those from the David Clark Co. via the OPC-871 HEAD SET ADAPTOR, the transceiver outputs your transmitted voice to the headset for monitoring. (p. 17)

■ LCD backlight control

The backlight of the can be set OFF, Low or High.

- ➔ Push [DIAL] to toggle the backlight control; OFF, Low or High are available.

■ Dial select function OPTION

Use the dial select function to adjust the tuning behaviour of the [DIAL] keys—use 1 MHz tuning when you want to change the frequency in large increments; use regular tuning (25 kHz or 8.33 kHz) when you want to change the frequency in smaller increments.

- ① Push [V/M] to select VFO mode.
- ② Push and hold [DIAL(TS)] for 1 sec. to select the desired tuning increment.
 - 1 MHz tuning or regular tuning steps can be selected. (see diagrams at right)
- ③ Push and hold [DIAL(TS)] for 1 sec. to return to normal operation.



1 MHz tuning selected



Regular tuning selected

NOTE: Large tuning steps should be used only when you want to change the frequency in large increments. Please select regular tuning steps for normal operation.

■ Scan operation OPTION

- ① Push [V/M] to select memory mode or VFO mode, if necessary.
 - “MR” appears on the memory mode.
- ② Make sure the squelch level is set to the threshold point.
 - Set a squelch level (01 to 25) where the noise is muted.
- ③ Push [SCAN] to start scan.
 - To change the scan direction, turn [DIAL].
 - “SCAN (or P SCAN)” flashes while scanning.
- ④ Push [SCAN] again to stop the scan.

/// **NOTE:** Normal scan or Priority scan is pre-programmed by cloning. Please ask your dealer or system operator for details.

◇ NORMAL SCAN

•Memory lock scan

Repeatedly scans memory channels except skip (lockout) channels.

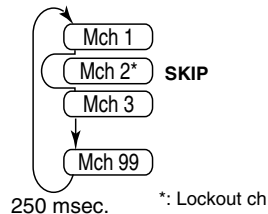

•VFO scan

Repeatedly scans all frequencies over the entire band. Scan step is minimum channel spacing. (e.g. 25 kHz or 8.33 kHz)

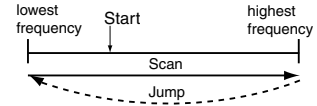

◇ PRIORITY SCAN

•Priority memory scan

While scanning on a memory mode, priority watch checks for a signal on the selected priority channel every 250 m sec except lockout channel.

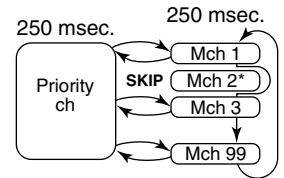

3 SCAN OPERATION

■ On-hook scan OPTION

On-hook scan (Hanger scan) is available when taking the microphone from its hanger (off-hook) and /or returning it into the hanger (on-hook).

- ① Push [SCAN] to start scanning.
- ② When receiving a signal, scan pauses until the signal disappears.
 - ➔ You can converse by taking the microphone from the hook.
- ③ Place the microphone on the hook to restart scanning.
- ④ Scan restarts 2 sec. after the signal disappears even if you did not converse the station.

When you take the microphone during the scan operation.

- ➔ In VFO scan; scan resumes promptly to frequency.
- ➔ In memory scan; scan resumes promptly to memory channel.
- ➔ In priority memory scan; scan resumes to priority channel.

NOTE: Be sure to connect the supplied microphone hanger to the vehicle's ground for on/off hook microphone functions. (p. 12)

■ Dualwatch

Dualwatch monitors priority channel while you are receiving an other channel (VFO or memory channel).

- If a signal is received on priority channel, dualwatch pauses on priority channel until the signal disappears.
- To transmit on the selected channel during dualwatch, push and hold PTT.

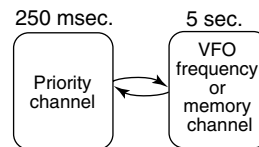

◇ Operation

- ① Select the desired operating channel (VFO or Memory channel).
- ② Push and hold [PRI] for 1 sec. to start dualwatch. 'P' blinks during dualwatch.
- ③ To cancel dualwatch, push [PRI] again.

■ Programming a memory channel OPTION

The transceiver has 99 memory channels for storage of often-used frequencies.

- ① Push [V/M] to select VFO mode, if necessary.
- ② Turns the [DIAL] to select the desired frequency.
 - Push [DIAL/TS] one or more times to use the dial select function, if desired.
- ③ Push [V/M] for 5 sec. to enter memory programming mode.
 - “MR” and memory channel number appear.
- ④ Turn the [DIAL] to select the desired memory channel number.
- ⑤ Push [V/M] for 1 sec. to program the information into the channel and return to VFO mode.
 - Push [SQL] for 1 sec. to clear the memory information.

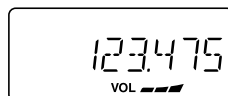
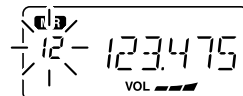
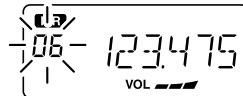

◇ Setting lockout channels

In order to speed up the scan interval, you can set memory channels you don't wish to be scanned as lockout channels.

- ① Push [V/M] to select memory mode, if necessary.
 - “MR” appears.
- ② Turn the [DIAL] to select a memory channel to set as a lockout channel.
- ③ Push [SCAN] for 5 sec. to toggle the lockout setting ON/OFF.
 - “LOCK OUT” appears when the channel is set as a lockout channel.



Memory channel 8 is set as lockout channel.

OPTION

NOTE: The VFO/memory switch [V/M] and the memory write switch [M/W] functions may not be available depending on version.

4 MEMORY PROGRAMMING

■ Memory names OPTION

◇ Programming memory names

- ① Select the memory channel to be programmed:
 - ➔ Push [V/M] to select memory mode.
 - ➔ Turns [DIAL] to select the memory channel.
- ② Push [V/M] for 5 sec. to enter memory name writing mode.
 - The first character of the name flashes.
- ③ Turns the [DIAL] as many times as necessary to enter the desired name.
 - To erase a character, overwrite with a space (displayed as _).
 - To move the cursor forwards or backwards, use [▲] or [▼].
 - Push [SQL] for 2 sec. to erase all characters.
- ④ Push [SCAN/MW] for 2 sec. to input the set name.
 - Flashing stops.
 - Memory channels can be programmed with names of up to 7 characters in length.
 - When no name is programmed, the display shows the operating frequency.

NOTE: Push PTT switch to abort the programming memory name.

• The following characters can be used in names:

➔ **0 to 9, A to Z (capitals), (space), \$, %, ', (,), *, +, “, ”, -, /, <, =, >, ?, @, [, \,], ^, _ and `.**

[EXAMPLE]: Setting the name to “TOWER 2”

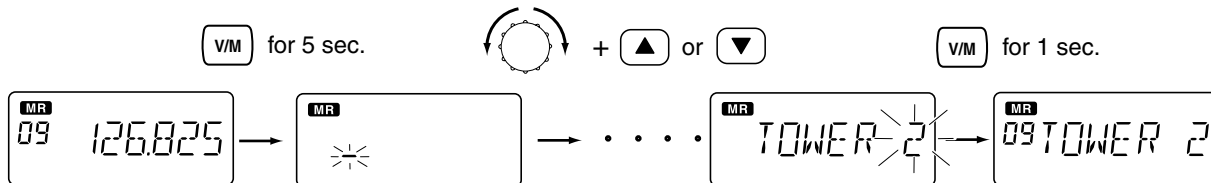

■ Initial set mode

Initial set mode is accessed at power ON and allows you to set seldom-changed settings. In this way you can “customize” transceiver operations to suit your preferences and operating style.

◇ Entering initial set mode

- ① While pushing and holding [V/M] + [TS(DIAL)], push [POWER] sw to turn power ON.
 - The transceiver enters initial set mode and “MN”, “BP”, “ST” or “PR” (p. 11) appears on the display.
- ② Push [TS(DIAL)] to select the desired item as described below and at right.
- ③ Turn [DIAL(TS)] to select the desired condition.
- ④ Push [SCAN] to exit initial set mode and select the previous operating mode.



◇ Memory names

This item allows you to display a memory name instead of frequency.

- When a memory channel has not been programmed with a name, frequency indication appears instead.

◇ Beep tones ON/OFF

Confirmation beep tones normally sound when you push a key. These can be turned ON or OFF as you prefer.

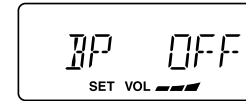
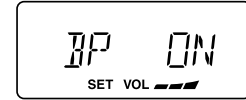

◇ Side tones ON/OFF

When using an optional headset such as those from the David Clark Co. via the adapter, the transceiver outputs your transmitted voice to the headset for monitoring.

- Optional **OPC-871 HEADSET ADAPTER** is required.

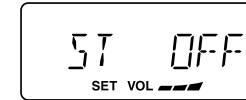
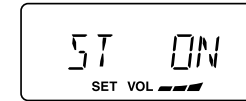

5 OTHER FUNCTION

◇ Priority channel OPTION

The priority channel is used to store your most often-used channel for quick recall. In addition the priority channel is monitored during priority scan modes. The default setting for the priority channel will differ depending on pre-programming.

➔ Push [PRI] to toggle the priority channel mode or previous mode.

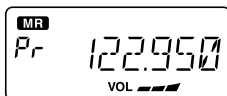

• Setting the priority channel

- ① While pushing and holding [V/M] and [DIAL(TS)], push [POWER] to turn the power ON.
 - The transceiver enters initial set mode.
- ② Push [TS(DIAL)] to select the priority channel set mode.
- ③ Select the desired channel number as a priority channel or OFF with [DIAL].
- ④ Push [POWER] to turn power OFF.

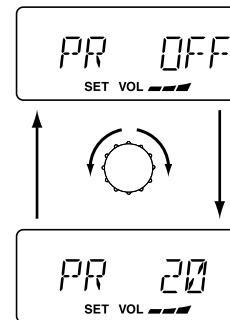

NEVER select the blank memory channel as the priority channel. In such case priority automatically sets to OFF position.

■ Rear panel and connections

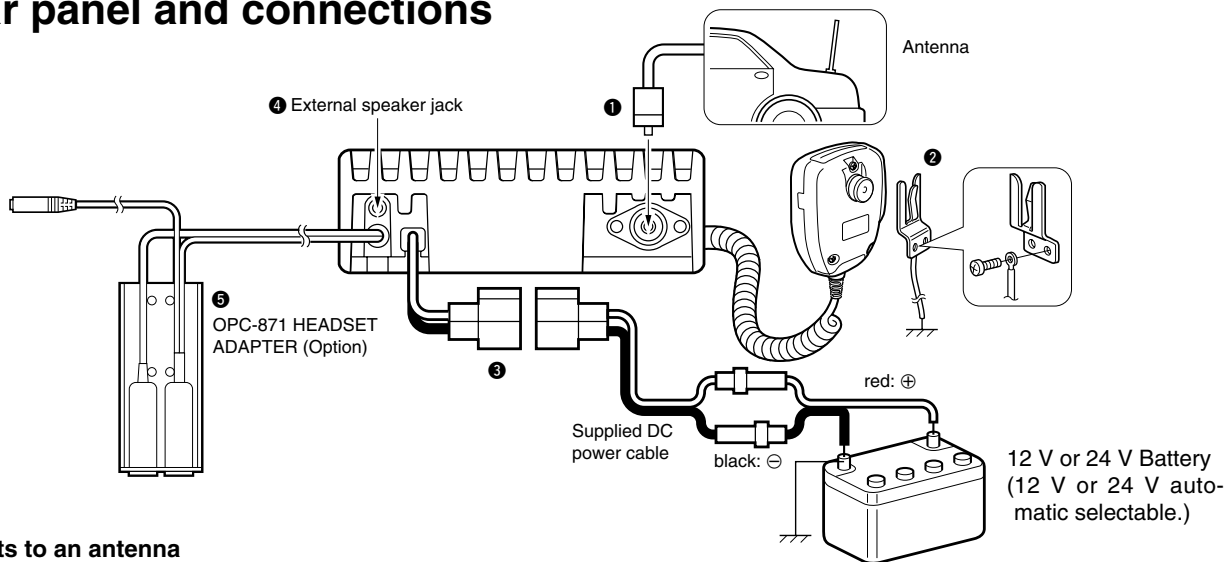

❶ Connects to an antenna

Ask your dealer about antenna selection and best installation location. (Standard 50 Ω antenna with a SWR <3.0)

❷ MICROPHONE HANGER

Connect the supplied microphone hanger to the vehicle's ground for hanger scan function when hanging or releasing the microphone.

❸ DC POWER RECEPTACLE

Connects to a 12 or 24 V DC battery. Pay attention to polarities.

- 12 V or 24 V automatic selectable.

❹ EXTERNAL SPEAKER JACK

Connect an 8 Ω, 10 W (Max.) external speaker, if desired.
CAUTION : Be sure to use the external speaker's power input rating more than 10 W, otherwise the speaker damage may occur.

❺ OPC-871 OPTIONAL HEADSET ADAPTER

Connect an optional headset. (See p. 17)

6 CONNECTION AND INSTALLATION

■ Mounting

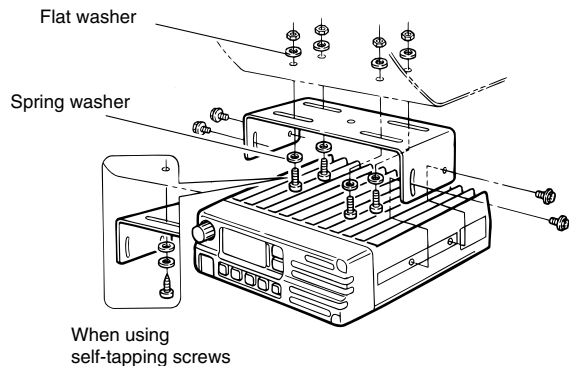

The universal mounting bracket supplied with your transceiver allows overhead or dashboard mounting. Please read the following instructions carefully.

- Mount the transceiver securely with the 4 supplied screws (M5 × 20) to a surface which is more than 10 mm thick and can support more than 5 kg.
- Mount the transceiver so that the face of the transceiver is at 90° to your line of sight when operating.

/// **IMPORTANT!**

Detailed installation notes for Icom mobile transceivers to be fitted into vehicles are available. Contact your Icom dealer or distributor.

■ Supplied accessories

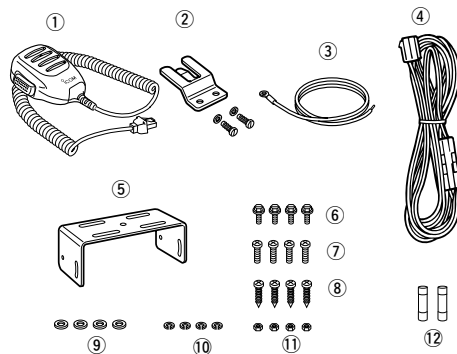

① Microphone	1
② Microphone hanger and screw set	1 set
③ Microphone cable	1
④ DC power cable (OPC-1091)	1
⑤ Mounting bracket	1
⑥ Bracket bolts	4
⑦ Mounting screws (M5 × 20)	4
⑧ Self-tapping screws (M5 × 20)	4
⑨ Flat washers	4
⑩ Spring washers	4
⑪ Nuts	4
⑫ Fuses (10 A)	2

◇ Data cloning

AT POWER ON

Cloning allows you to quickly and easily transfer the programmed contents from one transceiver to another transceiver, or, data from PC to a transceiver using the optional CS-A110EURO cloning software.

◇ Transceiver to transceiver cloning

- ① Connect the OPC-591 CLONING CABLE with adapter plugs to the [MIC] jack of the master and slave transceivers.
 - The master transceiver is used to send data to the slave transceiver.
- ② While pushing and holding [▲] + [▼] + [V/M], push [POWER] ON to enter cloning mode (master transceiver only—power ON only for slave transceiver).
 - “CLONE” appears and the transceivers enter the clone standby condition.
- ③ Push [POWER] on the master transceiver.
 - “CL-OUT” appears in the master transceiver’s display.
 - “CL-IN” appears automatically in the slave transceiver’s display.
- ③ When cloning is finished, turn power OFF, then ON again to exit cloning mode.

CLONE

CL-OUT

CL-IN

◇ Cloning using PC

Data can be cloned to and from a PC (IBM compatible) using the optional CS-A110EURO CLONING SOFTWARE and the optional OPC-478 CLONING CABLE+ OPC-592 CLONING CABLE ADAPTER. Consult the CS-A110EURO CLONING SOFTWARE HELP message for details.

◇ Cloning error

When the display at right appears, a cloning error has occurred.

CL-ERR

- In this case, both transceivers automatically return to the clone standby condition and cloning must be repeated.

◇ General

- Frequency coverage : 118.000 to 136.975 MHz
- Channel spacing : 25/8.33 kHz
- Mode : AM (6K00A3E)
- No. of memory channels : 99
- Acceptable power supply : 13.75 V* or 27.5 V* DC
(negative ground) (*Automatic selection)
- Usable temp. range : -20°C to +55°C
- Frequency err : ±1 ppm (0 to +40°C)
- Current drain (at 13.75 V DC):
 - Tx : 5 A (at max. power)
 - Rx : 4 A (at max. AF)
 - 0.5 A (at stand by)
- Antenna impedance : Standard 50 Ω with SWR<3:1
- Dimensions : 150 (W)×50 (H)×180 (D) mm
(projections not incl.)
- Weight (approx.) : 1.5 kg

◇ Transmitter

- Output power : 9 W ±1.5 dB (+15 to +35°C)
9 W +2 dB, -3 dB (-20 to +55°C)
- Modulation depth : More than 85%
- Modulation compression : Linear: 85%, Max. : 95%
- Amplitude mod. distortion : Less than 10%
- Audio frequency response : +2 dB to -4 dB from
350 to 2500 Hz
More than -25 dB at 5000 Hz
(at 25 kHz channel spacing)
More than -25 dB at 3200 Hz
(at 8.33 kHz channel spacing)
- Adjacent channel power : Less than 60 dB
(at 25 kHz channel spacing)
Less than 50 dB
(at 8.33 kHz channel spacing)
- Conducted spurious emissions:
 - Less than -46dBm
(9 kHz to 30 MHz)
 - Less than -36 dBm for
harmonics
 - Less than -46 dBm for non-
harmonics (30 MHz to 1 GHz)
 - Less than -30 dBm for
harmonics
 - Less than -40 dBm for non-
harmonics (1 GHz to 4 GHz)

◇ **Receiver**

- Receive system : Double conversion superheterodyne
- Intermediate frequencies : 1st 38.85 MHz
2nd 450 kHz
- Sensitivity (at 12 dB SINAD) : Less than 5 dB μ V
- Squelch sensitivity : Less than -6 dB μ V (Threshold)
- Harmonic distortion : Less than 5% (at 30% mod.)
Less than 10% (at 90% mod.)
- Audio frequency response : +2 dB to -4 dB from
350 to 3000 Hz
(at 25 kHz channel spacing)
+2 dB to -4 dB from
350 to 2500 Hz
(at 8.33 kHz channel spacing)
- Audio noise : More than 40 dB
- Adjacent channel rejection : More than 60 dB
- Spurious response rejection : More than 70 dB
- Intermodulation response : More than 64 dB
rejection
- Blocking or desensitisation : More than 70 dB
- Conducted spurious emissions : Less than -57 dBm
(9 kHz to 1 GHz)
Less than -47 dBm
(1 GHz to 4 GHz)
- Cross modulation rejection : More than 70 dB
- Receiver dynamic range : Less than 6 dB

- Audio output power : More than 10 W (at 13.75 V
DC with 8 Ω load 60 % MOD.
10% distortion)
- Side tone : More than 100 mW (with
500 Ω load 60% MOD. 10 %
distortion)
- Audio output impedance : Ext. SP 8 Ω
Side tone 500 Ω

All stated specifications are subject to change without notice or obligation.

8 SPECIFICATIONS (VFO CHANNEL ID LIST)

- Channel spacing: 25 kHz (Actual frequency is displayed.)

Operating Freq. (MHz)	Channel spacing (kHz)	Channel ID (Displayed Freq.)
118.0000	25	118.000
118.0250	25	118.025
118.0500	25	118.050
118.0750	25	118.075
118.1000	25	118.100
etc		

- Channel spacing: 8.33 kHz

Operating Freq. (MHz)	Channel spacing (kHz)	Channel ID (Displayed Freq.)
118.0000	8.33	118.005
118.0083	8.33	118.010
118.0167	8.33	118.015
118.0250	8.33	118.030
118.0333	8.33	118.035
118.0417	8.33	118.040
118.0500	8.33	118.055
118.0583	8.33	118.060
118.0667	8.33	118.065
118.0750	8.33	118.080
118.0833	8.33	118.085
118.0917	8.33	118.090
118.1000	8.33	118.105
etc		

- Channel spacing: 8.33/ 25 kHz auto selection mode

Operating Freq. (MHz)	Channel spacing (kHz)	Channel ID (Displayed Freq.)
118.0000	25	118.000
118.0000	8.33	118.005
118.0083	8.33	118.010
118.0167	8.33	118.015
118.0250	25	118.025
118.0250	8.33	118.030
118.0333	8.33	118.035
118.0417	8.33	118.040
118.0500	25	118.050
118.0500	8.33	118.055
118.0583	8.33	118.060
118.0667	8.33	118.065
118.0750	25	118.075
118.0750	8.33	118.080
118.0833	8.33	118.085
118.0917	8.33	118.090
118.1000	25	118.100
118.1000	8.33	118.105
etc		

■ OPC-871 Headset adapter

When using an optional headset, such as those from the David Clark Co. via the adapter, the transceiver outputs your transmitted voice to the headset for monitoring. (pgs. 5, 10)

◇ Connection

PTT switch

Use a PTT switch with a 3.5 mm diameter plug, if required.

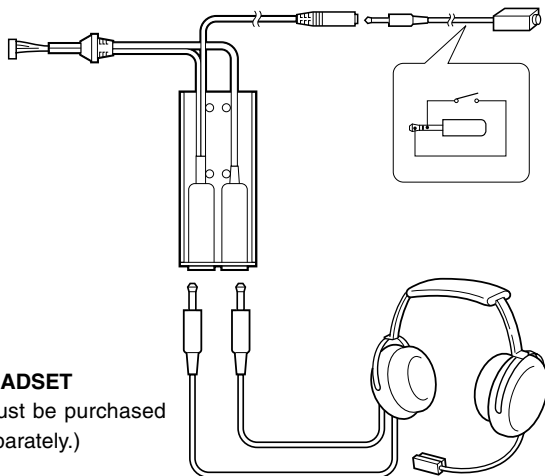

HEADSET

(Must be purchased separately.)

◇ Installation

The optional OPC-871 HEADSET ADAPTER install as follows.

- ① Turns the power OFF, then disconnect the DC power cable.
- ② Unscrew the 4 screws, then remove the bottom cover. (Fig. 1)
- ③ Insert the connector as shown below. (Fig. 2)
- ④ Mount the phone plug attachment together with the mobile mounting bracket with 2 supplied screws. (Fig. 3)

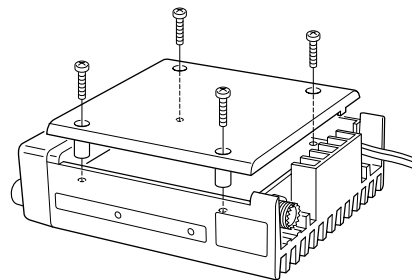

Fig. 1

9 OPC-871/OPTIONS

- Bent the plastic dust cover before install the strain relief into the notch.

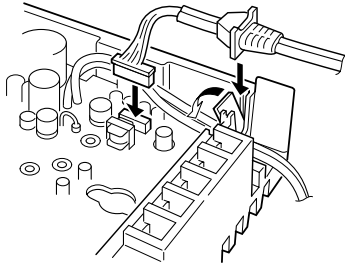

Fig. 2

- Use the upper side mounting hole.
- You can mount the attachment on either side of the transceiver.

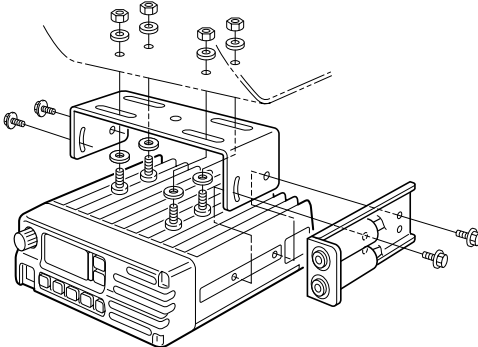

Fig. 3

■ Other options

OPC-871 HEADSET ADAPTER (See pgs. 18-19)

CS-A110EURO CLONING SOFTWARE

Provides quick and easy programming of items, including private channels, scan settings, etc., via an IBM® compatible PC (Microsoft® Windows® 95/98) to transceiver.

OPC-478 CLONING CABLE

OPC-592 CLONING CABLE ADAPTOR

These three components work as one set and provide a quick and easy programming of items, including memory channels, memory names and set mode contents, etc. via a PC.

OPC-591 CLONING CABLE

Cloning cable for transceiver to transceiver. Very convenient when programming cloning process. Allows transfer of programmed contents from one transceiver to another.

IBM is a registered trademark of International Business Machines. Microsoft and Windows are registered trademarks of Microsoft Corporation in the U.S.A. and other countries.



DECLARATION OF CONFORMITY

We Icom Inc. Japan
1-1-32, Kamiminami, Hirano-ku
Osaka 547-0003, Japan

Declare on our sole responsibility that this equipment complies with the essential requirements of the Radio and Telecommunications Terminal Equipment Directive, 1999/5/EC, and that any applicable Essential Test Suite measurements have been performed.

Kind of equipment: VHF AIR BAND TRANSCEIVER

Type-designation: IC-A110EURO

Version (where applicable):

This compliance is based on the following harmonised standards, specifications or documents:

- i) EN301 489-1*
- ii) EN301 489-22*
- iii) EN300 676
- iv) EN60950
- v) _____

* "Relevant EC Type Examination Certificate: reference CR 01-9781 issued by EMITECH (N.B number 0725) dated 20 July 2001"

CE0341 !

Düsseldorf 9th Nov. 2001
Place and date of issue

Icom (Europe) GmbH
Himmelgeisterstraße 100
D-40225 Düsseldorf
Authorized representative name

T. Maebayashi
General Manager

Signature
Icom Inc.



CE Versions of the IC-A110EURO which display the "CE" symbol on the serial number seal, comply with the essential requirements of the European Radio and Telecommunication Terminal Directive 1999/5/EC.



This warning symbol indicates that this equipment operates in non-harmonised frequency bands and/or may be subject to licensing conditions in the country of use. Be sure to check that you have the correct version of this radio or the correct programming of this radio, to comply with national licensing requirement.

Count on us!

<Intended Country of Use>

- GER FRA ESP SWE
AUT NED POR DEN
GBR BEL ITA FIN
IRL LUX GRE SUI
NOR